

**KAROCK STATIONARY ROCK
BREAKER MK7 SERIES 4
7519-00000-04004**

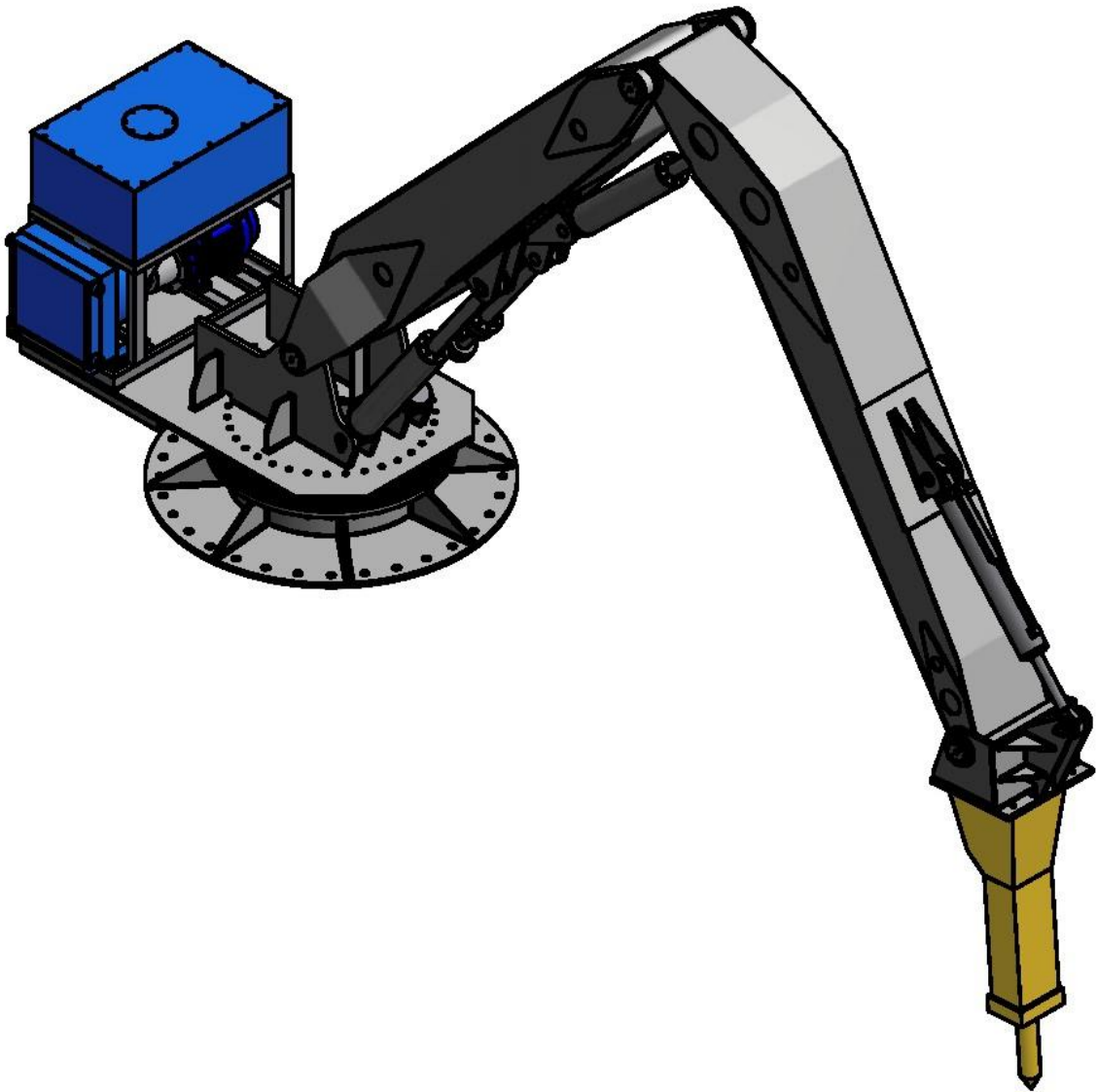

JDS Industries (Pty) Ltd., P O Box 1318, Klerksdorp

Tel: (018) 469 9900/01/02 * Fax: (018)469-9901

E-Mail: sales@jds-karock.co.za * Web Site: www.jds-karock.co.za

KAROCK STATIONARY ROCK BREAKER MK7 SERIES 4

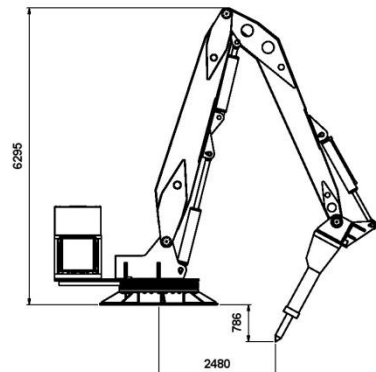
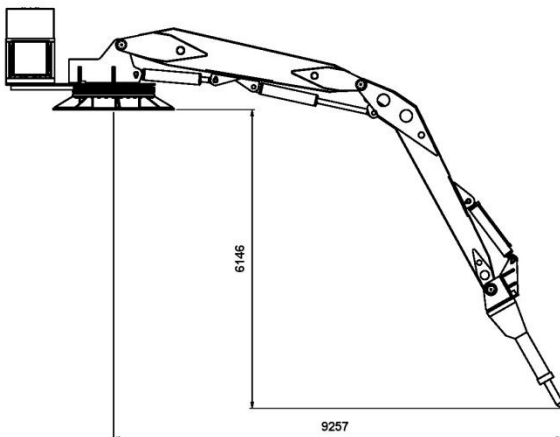
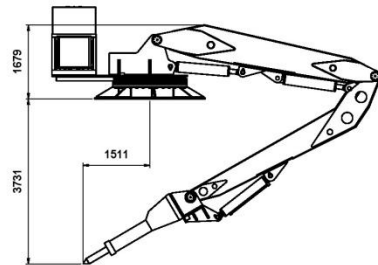
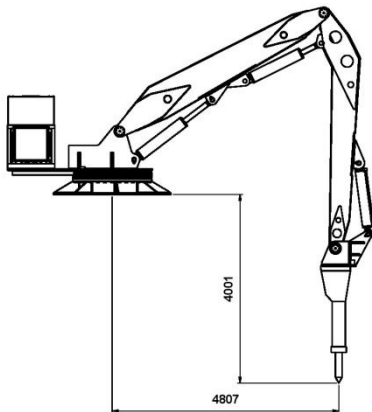
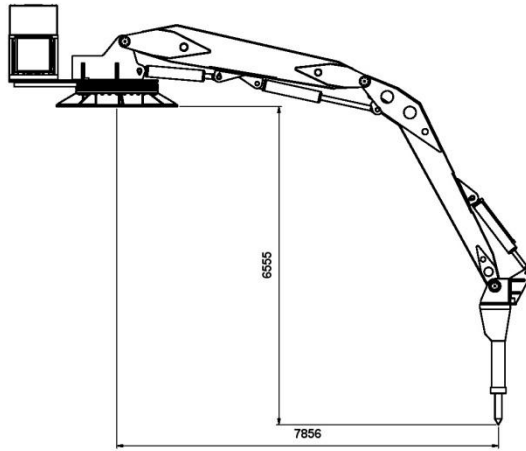

KAROCK STATIONARY ROCK BREAKER MK7 SERIES 4

MECHANICAL:

Max boom height with hammer in minimum reach position	6 295 mm
Min boom reach with hammer in vertical position	4 807 mm
Min boom reach with hammer 30° backwards tilt	2 480 mm
Max depth reach from Front pivot	6 146 mm
Max boom reach with hammer 30° Forward tilt	9 257 mm
Slewing angle	360° (180° left & right)
Base area	4 m ²
Weight Excluding Hammer	11 440 Kg

TECHNICAL FEATURES OF THE KAROCK ROCK BREAKERS

THE BOOM

The impact breaker is largely as a raking tool. Gravel and rock lying on top of the oversized rocks have to be moved aside, to be able to get to the blocked grizzly underneath. This puts high side loads and twisting moments on the boom structure.

Our design incorporates the following features:

- 1.1 Extra long and heavy pins, hardened and ground
- 1.2 Internally welded girder type reinforcing, torsion stiffeners
- 1.3 Heavy duty fork heads with long side reinforcement

The boom is calculated using a safety factor of 8 for combined stress.

THE SLEWING ARRANGEMENT

To lower the bearing load, the bearing centers are spaced as far apart as possible. Spherical plain radial and axial bearing are used for maximum load and minimum sensitivity to vibrations.

Top and bottom bearing arrangements are identical and interchangeable.

The bearing housing are bolted to the base pedestal and slewing bracket and can easily be maintained and replaced. (No welding)

Lubrication is done through internal porting, avoiding ingress of dirt.

THE HINGE PIN ARRANGEMENT

An impact breaker is classed as a vibratory machine. Ordinary ball bearing, roller bearing and sleeving rings are prone to pitting and brinelling due to stationary vibrations.

Pins and parallel bushes are prone to seizing and elongation, making stripping and maintenance difficult.

We use:

- 1.1 Spherical plain bearing with self alignment
- 1.2 Case hardener pins with internal grease points allowing clean grease to reach the bearings
- 1.3 Pin retainers that act as spacer bushes and also prevent the pin from turning in the bush.

ADVANTAGES

Good bearing wear life

Easy to dismantle

Off the shelf replacement parts (bearing and seals)

Dirt free lubrication

HYDRAULICS

There are Two type of Hydraulic systems which are available on customer request the standard Hydraulic Pilot Operated system and the Electro Hydraulic Operated system the latter is recommended when the customer intends to use Radio Remote Controls.

The reservoir is a fully welded construction with an internal baffle plate as well as two manhole covers for ease of cleaning.

A drain valve is fitted onto a slope bottom plate.

The complete electric motor, bell housing, coupling and pump assembly can be fitted out in one piece be loosening two hydraulic pipe connections and eight flange mounting bolts.

Hydraulic Pumps : Option fitted at customer's request.
Options : gear pump rated at 210 bar.

As we run the unit at a maximum of 180 bar pressure, all pump types are suitable but obviously the life expectancy of the internal gear pump is higher.

Couplings:

We utilize the Bowex gear tooth coupling with a nylon sleeve. Should the drive system for any reason become overloaded the nylon sleeve will shear, thus providing an additional safety feature.

Hydraulic oil filtration:

Inline filters in pressure lines
8 Micron fine, filtration on return line with blocked filter bypass valve.

Pressure control:

This is done via hydraulic relief valve in the hammer and cylinder pressure lines.

Hammer control:

In additional to the self contained hammer activation mechanism built into the hammer, we have electric/hydraulic pilot operated relief valve. This enables the operator to activate and control the hammer efficiently.

HYDRAULIC CYLINDERS

All cylinders are designed to Din standard, rated at 250 bar and are pressure checked to 350 bar

Features:

End cushioning to eliminate shocks
Manifold mounted over center valves to stop boom from creeping during down-wards movement and to stop boom movement during hose failure

Spherical bearings are fitted to both cylinder clevises

Interlocks and safety features:

Low oil level cut out
High oil temperature cut out (87° C)
Temperature and level indicator on tank
Minimize pressure check points on all pressure lines.

ELECTRICALS ON BREAKERS

22, 30, 37, 45 and 75 kW 4 pole TEFC electric motors

Frame size 2255 flange and foot mounted
380/525/1000 Volt
IP 55 B 3/5
Cast Iron

The switchboard consists of a double door splash proof box containing all necessary starting functions and safety interlocks.

Special Features:

Phase reversal protection
High oil temperature cut out
Low oil level cut out
Hour meter
AMP meter
Hydraulic oil cooled by force cooling

The panel contains a start / stops and reset button for maintenance.
A remote start / stop button is located at the operators position for operation during the work cycle.
All fault indication is shown via pilot lights on operator's panel.

Radio Remote Control is an optional request from our customers and is a hand held Remote Control which can be operated up to a 100 meter radius from the Karock Rock Breakers.